

**Optical sorting  
for pet food.**

Making product  
recalls a thing of  
the past.

# Optical Sorting from Bühler. **Equipment and Solutions.**

<b>1</b>	Why sort pet food?	4
<b>2</b>	SORTEX® F optical sorter.	5
<b>3</b>	Technology meets hygienic design.	8
<b>4</b>	3-in-1 interconnected detection technology.	9
<b>5</b>	SORTEX® A optical sorter.	10
<b>6</b>	Digital know-how and solutions.	12
<b>7</b>	Technical details.	14



# A leading supplier of optical sorting solutions. **An integral part of the pet food industry.**

Bühler is a leading global supplier of optical sorters as well as a complete solution provider of pet food machinery (i.e. grinding, mixing, extruding, drying, bagging, etc.). Our ability to provide complete solutions combined with in-depth industry experience gained over multiple decades allows us to offer the best solution to each of our customers.

With a commitment to substantial investment in research and development, we at Bühler are committed to developing state-of-the-art technology that empowers processors to confidently meet stringent food safety and quality requirements to maximize their productivity and profitability.

Consequently, pet food producers can be certain of world-class performance when placing Bühler's optical sorters in their production lines.

## **Why Bühler?**

- Complete solution provider for pet food with in depth process understanding
- Application centers to run trials with your pet food product
- Excellent customer service with more than 100 service stations all over the world
- Solutions designed for best performance and high feed safety standards

# Why sort pet food?

## Make product recalls a thing of the past.

### Biggest threats in pet food production.

#### 1 Foreign material.

No more grains, plastic, strings, stones, etc. Fewer rejected shipments, less customer complaints/recalls.

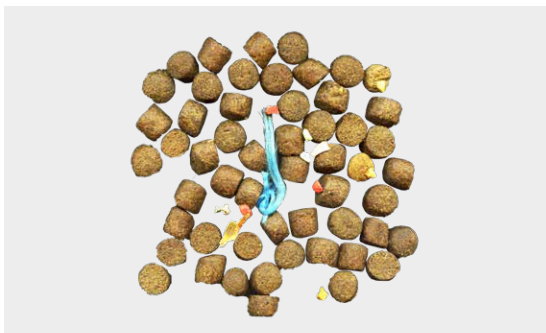

#### 2 Cross contamination.

Reduction in undesirable colors and shapes. High product quality and less downtime due to cleaning.



#### 3 Under-/oversized.

Uniform product of equal size.  
Less broken and kibbles sticking together.



#### 4 Aflatoxin.

Aflatoxin in corn is not visible and has been a serious challenge for US based pet food producers recently.



#### 5 For any other applications, please contact us.

### The solution for premium pet food.

Recent recalls have also been a reminder of how paramount safety is in pet food production. Furthermore, customer expectations of the quality of pet food are continuously increasing. The biggest risks arise from foreign material, cross contamination, under- and oversized kibbles as well as aflatoxin in raw material. Optical sorters from Bühler with removal efficiencies of up to 99% offer solutions to these pressing issues and allow pet food producers to manage their risk and subsequently lower the probability of any costly product recalls.

# SORTEX® F optical sorter.

## For the safest, highest quality pet food.

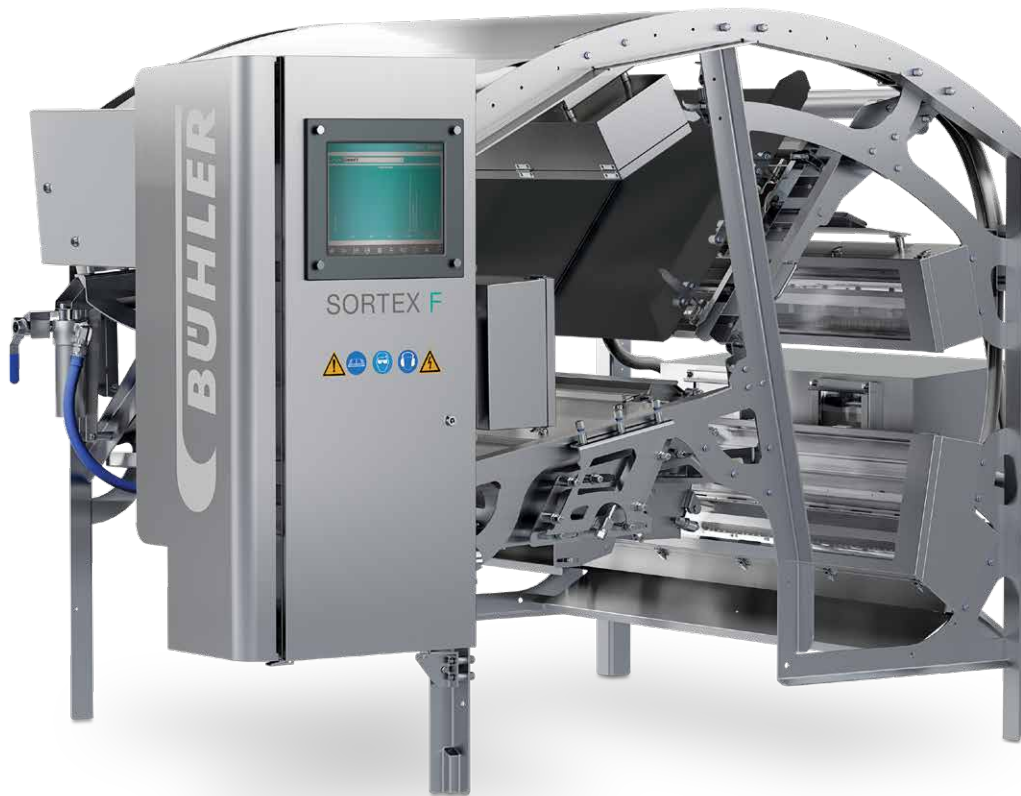

**The industry's most hygienic optical sorter, developed for pet food processors is now available featuring technology that has transformed the nuts and frozen fruit and vegetables industries.**

SORTEX F technology offers pet food producers 3-in-1 detection of foreign material, cross contamination and under-/oversized kibbles in just one optical sorting platform. The unique open design frame also minimizes the risk of bacterial contamination thanks to its easy cleaning access, hygienic grade fixings and sloped surfaces.

This pioneering sorter is best positioned as close as possible to the packing line for the highest end product quality.

- Capacity up to 12t/h
- Highest food safety standards, open design
- Ease of operation
- Available with one/two modules
- Simultaneous re-sorting for best efficiency

# SORTEX® F optical sorter.

## At a glance.

### 1 Accessible, stainless steel frame

Every element from the stainless steel frame and sloped surfaces to the hygienic screws has been carefully selected with food safety in mind – leaving no detail untouched.

### 2 Anodized, adjustable chute

Available in 600 mm and 1200 mm the anodized chute provides an easy-to-clean surface for processing. With higher processing capacities and re-sort capabilities, the chutes are easily adjusted, allowing operators greater access inside the machine.

### 3 Unique open receptacle

Unique to Bühler, the receptacle can be easily opened and closed to give processors maximum access for cleaning, reducing the risk of contamination. This receptacle is combined with a state-of-the-art dust extraction system creating the optimum working environment.

### 4 State-of-the-art detection system

Available with pioneering SORTEX technology – this unique configuration of detection technologies includes color cameras for simultaneous detection of color defects, and foreign materials.

### 5 LED XENON foreground lighting

Provides consistent broad-spectrum lighting across the view for more uniformity with less shadowing.





## 6 LED background

With red, green and blue backgrounds, processors can define the optimal sorting mode dependent on of the product being sorted.

## 7 Larger, 17-inch user interface

Enhanced user interface features a larger screen and controls, simplifying usability for the operator.

## 8 SORTEX ProSortX 4.0 operating software

ProSortX 4.0 builds on the success of the original ProSortX with a clean new look, Industry 4.0 readiness and a host of new features.

It makes setting up and using the Sortex F easy and efficient, saving operators time and offering peace of mind.

## 9 Smart Sorting capabilities

Featuring self-learning capabilities with pre-set and user-defined modes for click-and-forget sorting that minimizes operator intervention.

## 10 Ultra-modern cooling system

Maintaining consistent temperatures across the entire sorting function, this integrated system enables consistent component performance and product quality.

# At the leading edge of optical sorting. **Technology meets hygienic design.**

With Competence Centers around the world and an Optical Sorting headquarters in London, our Researchers, Engineers and Product Developers work in partnership with our customers to develop proprietary technologies that have been at the forefront of the optical sorting industry since 1947.

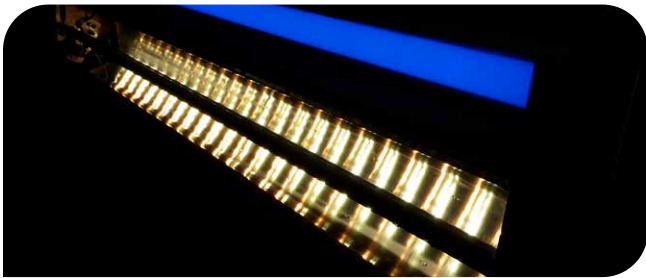

## **Sophisticated LED lighting.**

Sophisticated LED-Xenon foreground lighting provides the ultimate broad-spectrum lighting for greater uniformity with less shadowing. Additionally, new LED background lighting comes with red, green or blue options to ensure optimal sorting performance is achieved, no matter the application being sorted.

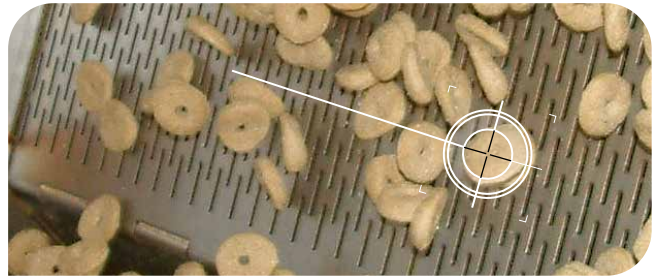

## **Intelligent ejector technology.**

SmartEject™ - high speed, high flow ejectors efficiently remove defects with pinpoint precision and accuracy.

## **Designed with hygiene and food safety in mind.**

The combination of a stainless steel frame, hygienic fixings and an open design results in the most hygienic sorter for pet food in the market.





# SORTEX® F optical sorter technologies.

## 3-in-1 interconnected detection technology.

### Sortex color cameras.

To remove any “object” with color variations from the specified accept colors (cross contamination from previous batches, colored foreign material, etc.)

### PROfile technology.

To remove any “object” with shape features which vary from the good product (broken, over-/undersized, cross contamination from previous batches with same color, etc.)

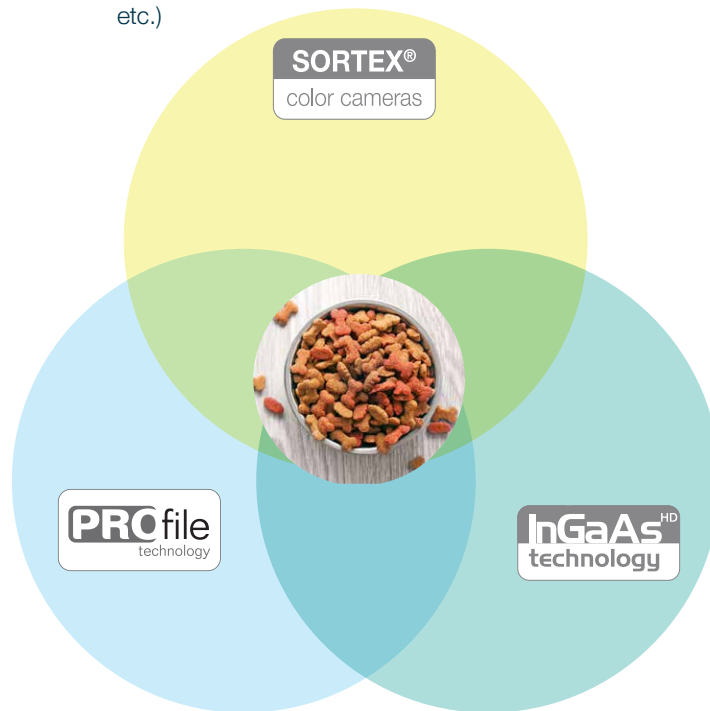

### InGaAs technology.

To remove any foreign material (grains, plastic, strings, stones, etc.)

## SORTEX® PROfile™ technology.

A combination of three dynamic technologies which enable Bühler optical sorters to perform even the most complex sorting tasks. Designed with multiple levels of shape, size and color detection to deliver a uniform product quality at the highest capacity possible. This unique double detection system analyzes produce from both sides to offer processors total quality assurance.

### PROsize™

As a progression from traditional grading solutions, PROsize™ can be employed in situations where product is too delicate or difficult to be sorted using conventional mechanical graders. This maximizes profitability by distinguishing the premium product.

### PROcolor™

Processors can define the maximum percentage of surface blemish based on retail or customer specifications, enabling them to grade products based on their physical appearance. This then maximizes commodity value by defining multiple grades of quality product.

### PROshape™

PROshape™ is an intelligent detection technology which inspects the product based on shape criteria when the defective product is the same color as the good product.

# SORTEX® A LumoVision. The most efficient and reliable way to remove and monitor aflatoxin.

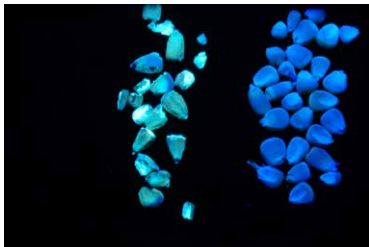

Contaminated grain (fluorescent green) and healthy grain (fluorescent blue.)

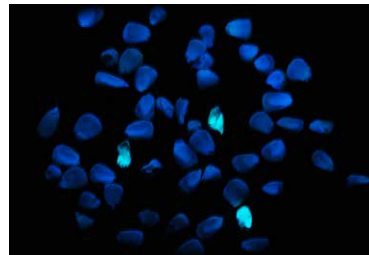

Contaminated grains mixed with healthy grains

**LumoVision is the first optical sorting technology able to identify aflatoxin based on direct indicators of contamination, while simultaneously using real-time, cloud-based data to monitor and analyze contamination risk.**

Pet food producers, particularly in the US, face ongoing challenges regarding aflatoxin in pet food. This threat has led to multiple product recalls. Aflatoxin is highly poisonous in small doses and tends to occur in hot spots which makes detection a challenge for manufacturers and suppliers. In addition, traditional removal techniques such as sieving, pearling, washing among others have shown limited effectiveness in reducing contamination efficiently.

With LumoVision, food, feed, and pet food manufacturers can protect their product from contamination, avoid the cost of expensive recalls and reputational consequences, while increasing yields and reducing waste.

- Capacity up to 20t/h
- Yield loss less than 5% minimizing waste
- Up to 90% Aflatoxin reduction
- Highest process control results in lower risk of product recalls



**Making product recalls  
a thing of the past.**

By using optical sorting, pet food producers can reduce their risk of product recalls by 95% or more.

# Digital know-how and solutions. A partnership you can count on entire asset lifecycle.

You send us your technical requirements and product photos, including any defects. If your application has been processed by our machinery before we can refer to our database of over 10,000 samples to propose one of our tried and tested solutions. If your commodity has not been tested by us before, we invite you virtually via livestream to run a small-scale sample test. Alternatively, you can visit one of our 14 applications labs located all around the world.

Based on the test results, we collaborate with you to create a bespoke Sortex solution that you are confident in, that will suit your unique processing requirements and enhance your business performance.

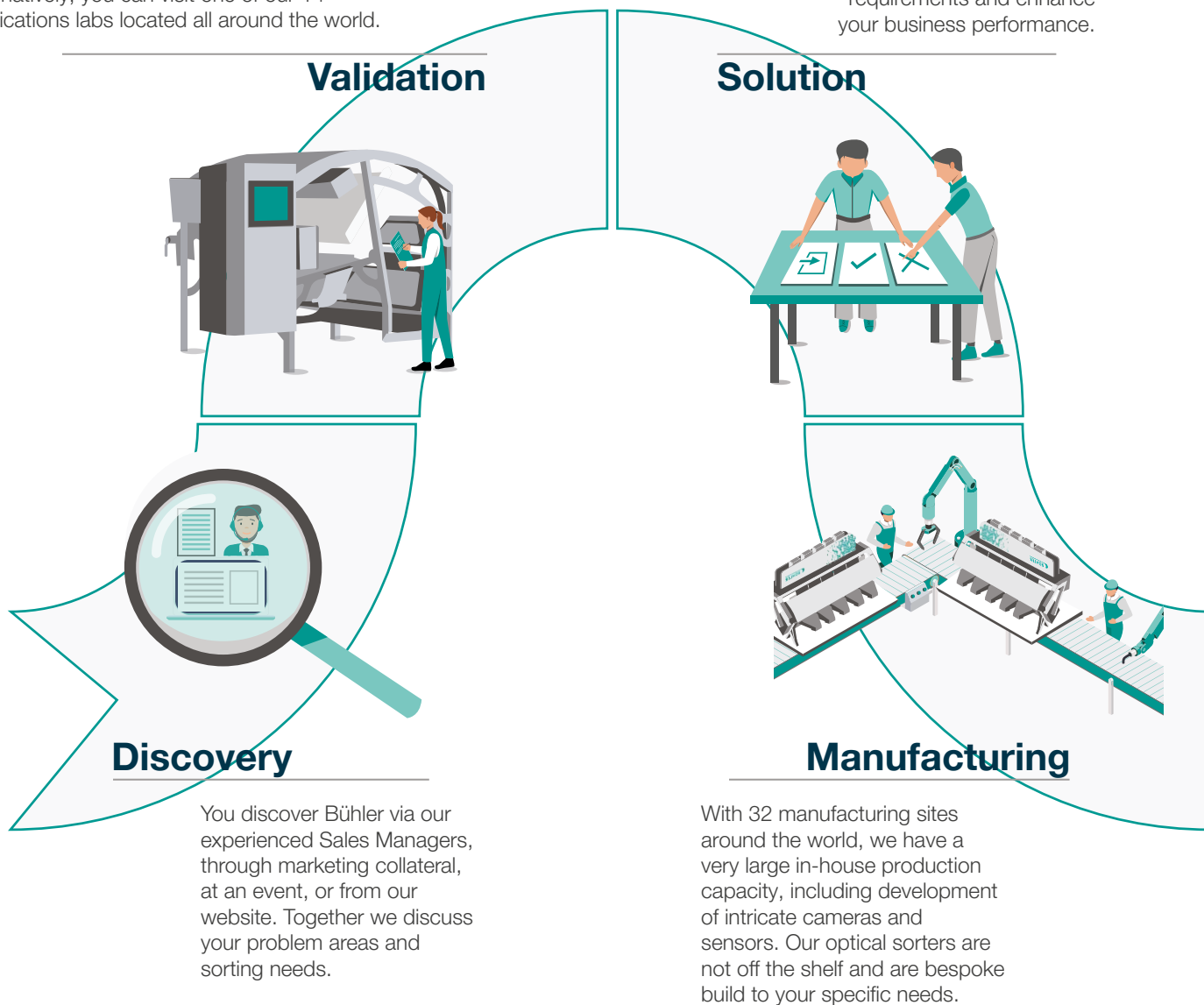

Our sorters are intuitively designed for easy operation and flexibility with quick product changeovers. We offer operator training courses conducted by our Service Engineers on-site at your plant.

Our state-of-the-art digital solutions powered by Bühler Insights drive gains in performance, productivity and efficiency. Ensure maximum uptime, avoid product wastage and spot quality issues using actionable insights and real-time alarms from individually connected sorters up to entire processing lines.

## Operation

## Digital Solutions

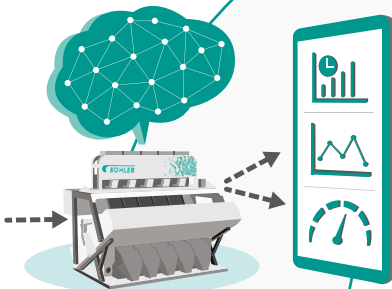

## Installation

## Performance Optimization

Using integration drawings, the machines are fitted and tested by our experienced and highly trained local language speaking Service Engineers. They connect the machine to your plant's automation system using PLC or other plant networks.

As a member of the Bühler family we offer you access to a range of aftercare solutions designed to enhance performance.

Tests, repairs and remote support from our Service Engineers based at more than 100 service stations around the world.

myBühler portal – our trusted customer portal which provides you with all the information you'll need to run your Sortex machine.

TotalCare – our service package for repairs and performance optimization.

Retrofit services – which allow you to update or upgrade your machine, increasing its lifecycle.

# Technical details.

## SORTEX® F.

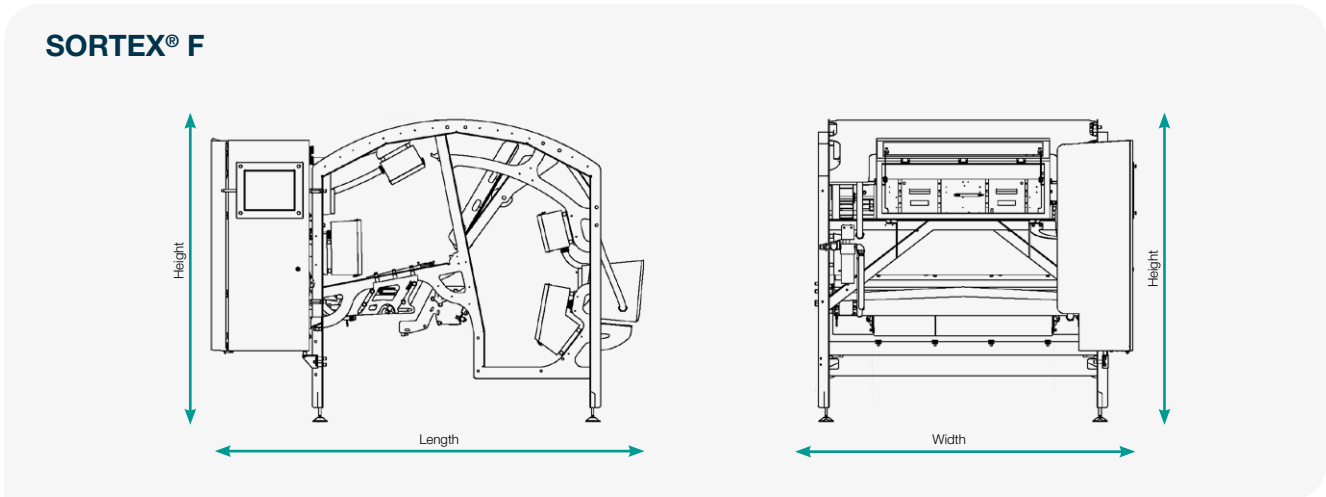

### Product options

Features and Specifications	SORTEX® F
Color Cameras	Standard
InGaAs <sup>HD</sup>	Optional
PROfile™ technology	Standard
LED Background lighting	Standard
LED-Xenon lighting	Standard
Remote access	Optional
SORTEX ProSortX™	Standard
TotalCare Performance Protection	Optional

For the full feature list and product specifications contact your local representative.

Standard Optional

### Dimensions, air and power requirements

SORTEX® F Range	Chute size mm (inches)	Width mm (inches)	Length mm (inches)	Height mm (inches)	Weight* kg	Typical air requirements (l/s)* 102-116 psi (7-8 bar)	Typical Power consumption (kW)** (200-240 V; 50/60 Hz single phase)
SORTEX FB1	600 (23.62)	1610 (63.38)	3010 (118.51)	2112 (83.15)	850	Standard 32 Ejector* 45	2.4
SORTEX FB2	1200 (47.24)	2210 (87.10)	3004 (118.27)	2112 (83.15)	1250	Standard 65 Ejector* 90	4.75

# Technical details.

## SORTEX® A LumoVision.

### SORTEX® A LumoVision

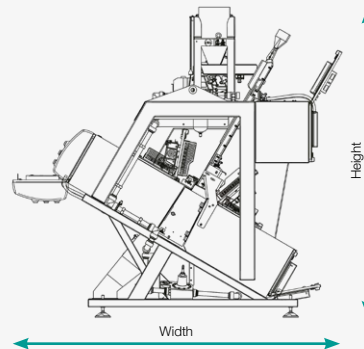
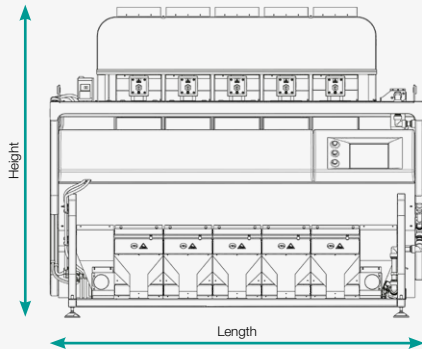

### Product options

Features and Specifications	SORTEX® A LumoVision
LumoVision Cameras	■
PROfile™ Technology	■
UV LED Lighting	■
Climate Control	●
Remote Access	●
SORTEX ProSortX™	■
CE Certification	■
ATEX	●
TotalCare Performance Protection	●
Available Modules (all on 5 module frame)	3 – 5

For the full feature list and product specifications contact your local representative.

■ Standard ● Optional

### Dimensions, air and power requirements

Machine	Width mm (inches)	Depth (Doors Open) mm (inches)	Depth (Doors Shut) mm (inches)	Height mm (inches)	Weight* kg	Typical air requirements (L/s)** 72-102 psi (5- 7bar)	Typical Power consumption (kW)*** (200-240V; 50/60 Hz single phase)
A5	2387 (93.98)	2333 (91.85)	1708 (67.24)	2088 (82.20)	1150	40	4.5

\* Unpacked weight. Figures will vary based on machine specifications

\*\* Figures will vary based on contamination levels \*\*\* Figures will vary based on machine specifications

© The Bühler Group 2021

SORTEX® is an internationally registered  
trademark of the Bühler Group

## **Buhler Inc.**

13105 12th Ave N  
Plymouth, MN 55441  
T +1 763 847 9900

[sortexsales@buhlergroup.com](mailto:sortexsales@buhlergroup.com)  
[www.buhlergroup.com](http://www.buhlergroup.com)

Pet food sorting en 0521 Z&B 211217